

מלחמת סיני 1956

"TO NIGHT THE ISRAELI ARMY GOES TO WAR".



בתמונה מאיר פרידנזון ז"ל (מייסד החברה)

פרידנזון הנדסה בע"מ
(משנת 1978)

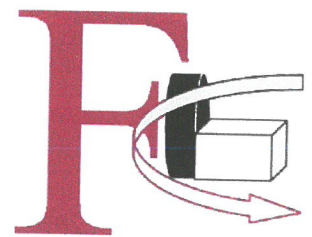

כתובת: הנפח 12 א.ת. חולון 5881806
טלפון: 03-5591563, פקס: 03-5567620

www.fridenson-eng.co.il

SHLOMOFRIDENSON@GMAIL.COM



... pleased to introduce our innovative belt collection, branded Non Detecting Belts, designed to combine premium quality, everyday comfort, and a unique functional advantage highly relevant to today's consumers.

Product Range:

Men's Belts

- 38 mm width – Brown
- 35 mm width – Black

Women's Belts

- 32 mm width – Black

- Made from genuine high-quality leather
- Non-detecting in standard airport security checks – no need to remove the belt during screening
- Uniquely designed with larger-than-standard pin holes, allowing fast, easy, and comfortable fastening – including for customers who find traditional belts less convenient
- Israeli development with manufacturing in India, enabling excellent quality at highly competitive pricing

These belts are particularly appealing to frequent travelers, business professionals, and customers seeking both practicality and refined design. The combination of innovation, comfort, and attractive pricing creates

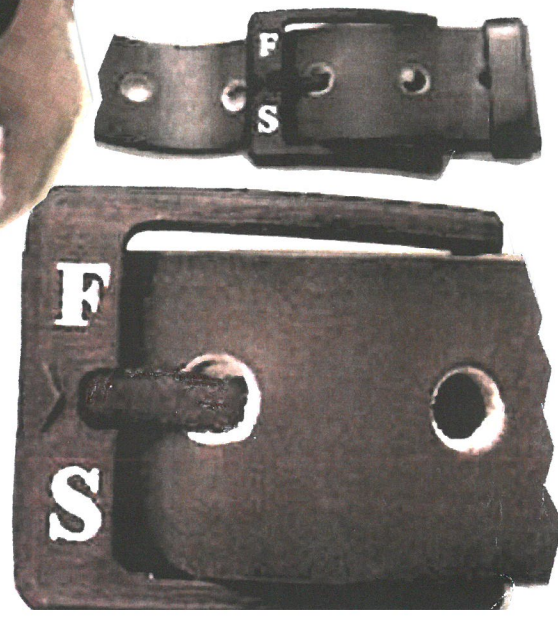

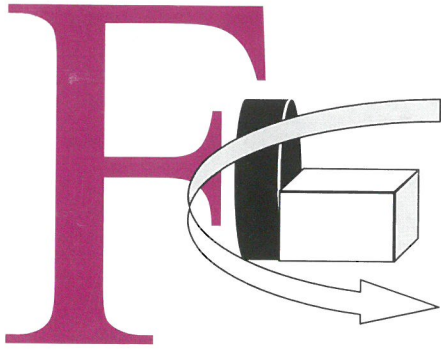

FRIDENSON Engineering Ltd.

Phone: 972-3-5591563 E-mail: fridenson-ltd@bezeqint.net Web site: www.fridenson-eng.co.il

Production under same roof using all technologies and all materials sorts

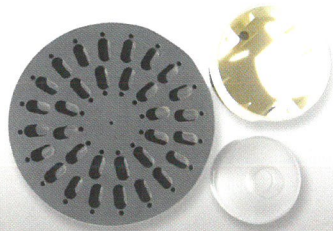

Plastic Machining



Steel Forging



Forged Rolling Thread

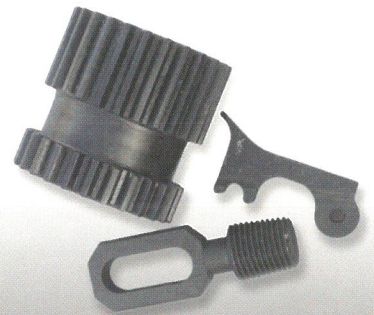

Steel Machining

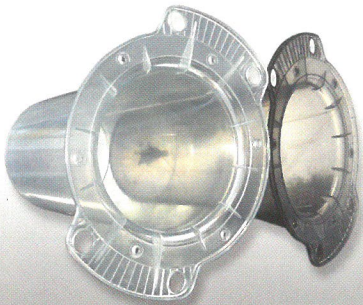

Plastic Injection



Bronze & Brass



Sheet Metal Work



Precision Casting

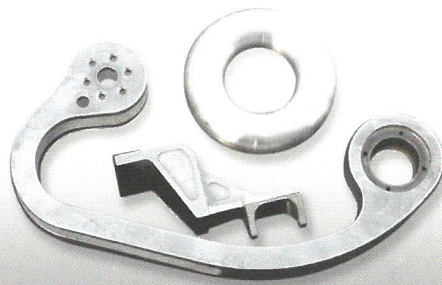

S.St Machining

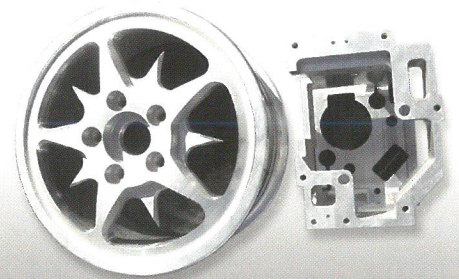

Aluminum Machining



Steel & Aluminum Casting

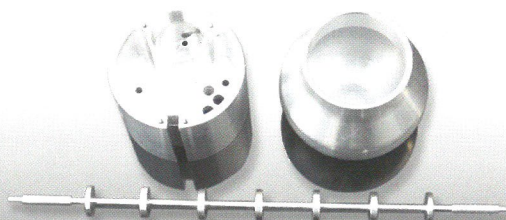

Tiny Aluminum Machining



Rubber & Wood

ייצור מדידים מדויקים לתעשייה

הערות:

- א חומר: פלדת כלים TYPE O1 OR O1 לפי תקן: DF-2 OR ASTM A681
- ב חומר: פלדה SAE 1040 לפי תקן: ASTM 109
- ג טיפול: לחסם לקושי 58-62HRC לפי תקן: DOD-P-16232
- ד טיפול: פוספטציה עם שימון, TYPE M CLASS-2 לפי תקן: DOD-P-16232
- ה אם לא צויין אחר: הסיבולת עבור מידות: ± 0.25 כל הפינות $0.5 \times 45^\circ$
- ו סמן בפנטוגרף או הטבעה עמוקה ומלא בצבע לבן את הסימון 1-74.85-3.
- ז ניתן לייצר חלק זה ממס' חלקים.

63 / (16 /)

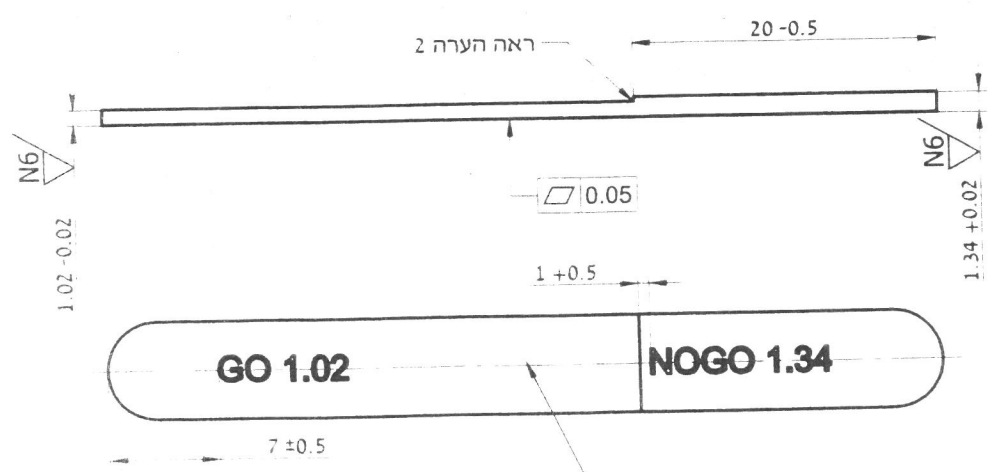
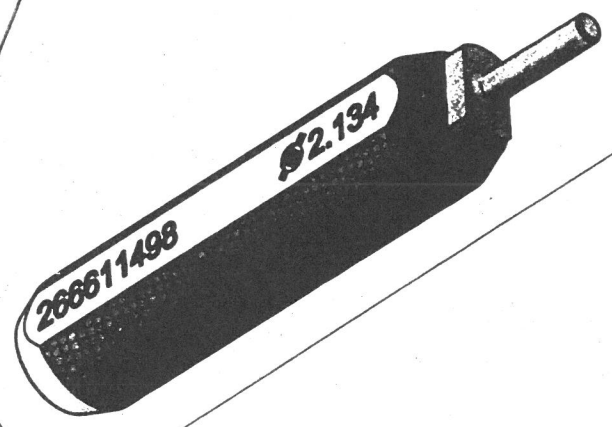
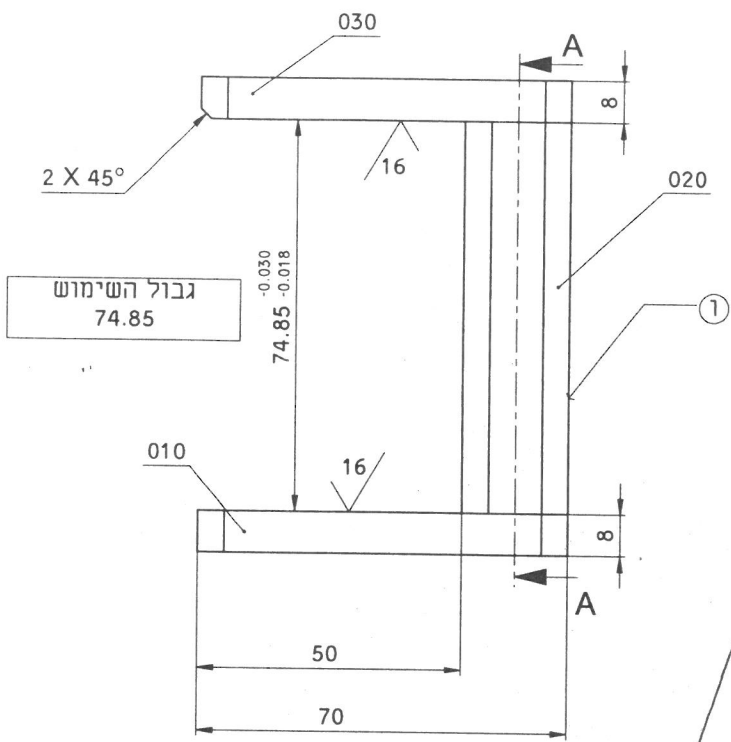

מיקום לסימון מסייד

CERTIFICATE

No. I31739A



This is to certify that
The Quality Management System of
Fridenson Engineering Ltd.
12 Hanapach St. Holon, Israel

Was audited by IQC and found to be
in compliance with the requirements of the standard:

ISO 9001:2015

This certificate is valid for the following scope of activities:
**Engineering design, engineering plastic, mechanical parts
supply**

This certificate is valid until:	14.06.2026
Certification cycle will end on:	14.06.2028
Date of previous certification cycle:	14.06.2025
Date of certification decision:	18.05.2025
Date of first approval:	14.06.2022

This certificate is subject to the continuing satisfactory operation
of the Management System and periodic auditing by IQC

19.05.2025
Issue Date

Nir Halpern, CEO

IQC - Institute of Quality & Control
9 Shamira Imber Gadish st. Kiryat Ono, Israel
Tel: 03-9313555
E-Mail: info@iqc.co.il, www.iqc.co.il

